

Инструкция по установке

# MITSUBISHI OUTLANDER XL





(2006-2012)

# PEUGEOT 4007

(2007-2012)



Арт.: F.4012.001

 1500 kg	 75 kg	 $D \text{ (kN)} = \frac{\text{MAX kg} \times X}{\text{MAX kg} + \text{MAX kg}} \times 0,00981$ 
D = 8.7 kN		



Вкрутить/выкрутить используя инструмент

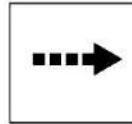

Движение

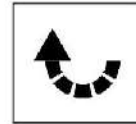

Поворот



Вкрутить/выкрутить не затягивая

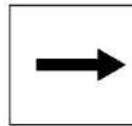

Расположение

### Используемый инструмент:

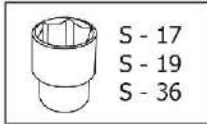
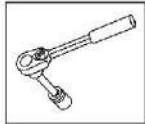







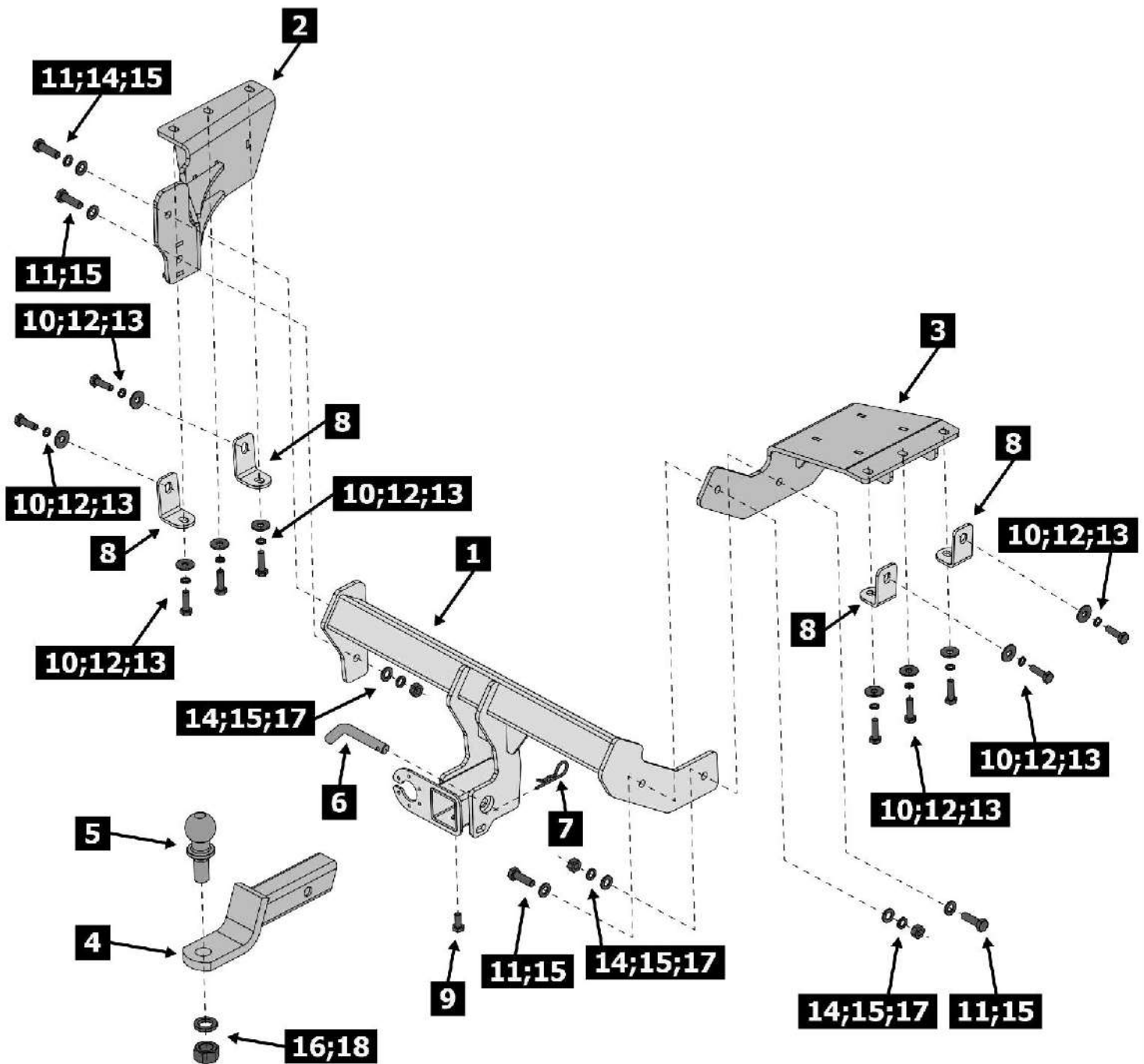

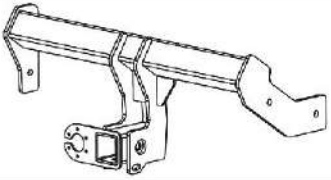
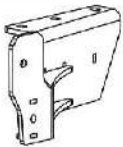
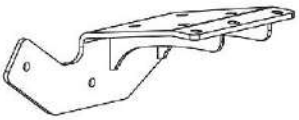
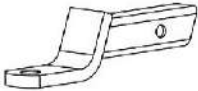
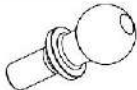

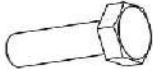

S - 17  
S - 19  
S - 36

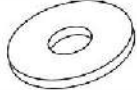

Office Knife



<b>1</b>	x1	Балка	
<b>2</b>	x1	Кронштейн балки левый	
<b>3</b>	x1	Кронштейн балки правый	
<b>4</b>	x1	Переходник	
<b>5</b>	x1	Шар	
<b>6</b>	x1	Штифт	
<b>7</b>	x1	Шплинт	
<b>8</b>	x4	Уголок	
<b>9</b>	x1	M10x20	
<b>10</b>	x10	M10x1,25x35	
<b>11</b>	x4	M12x1,25x40	
<b>12</b>	x10	Ø10	
<b>13</b>	x10	Ø10	
<b>14</b>	x4	Ø12	
<b>15</b>	x7	Ø12	
<b>16</b>	x1	Ø24	
<b>17</b>	x3	M12x1,25	
<b>18</b>	x1	M24	

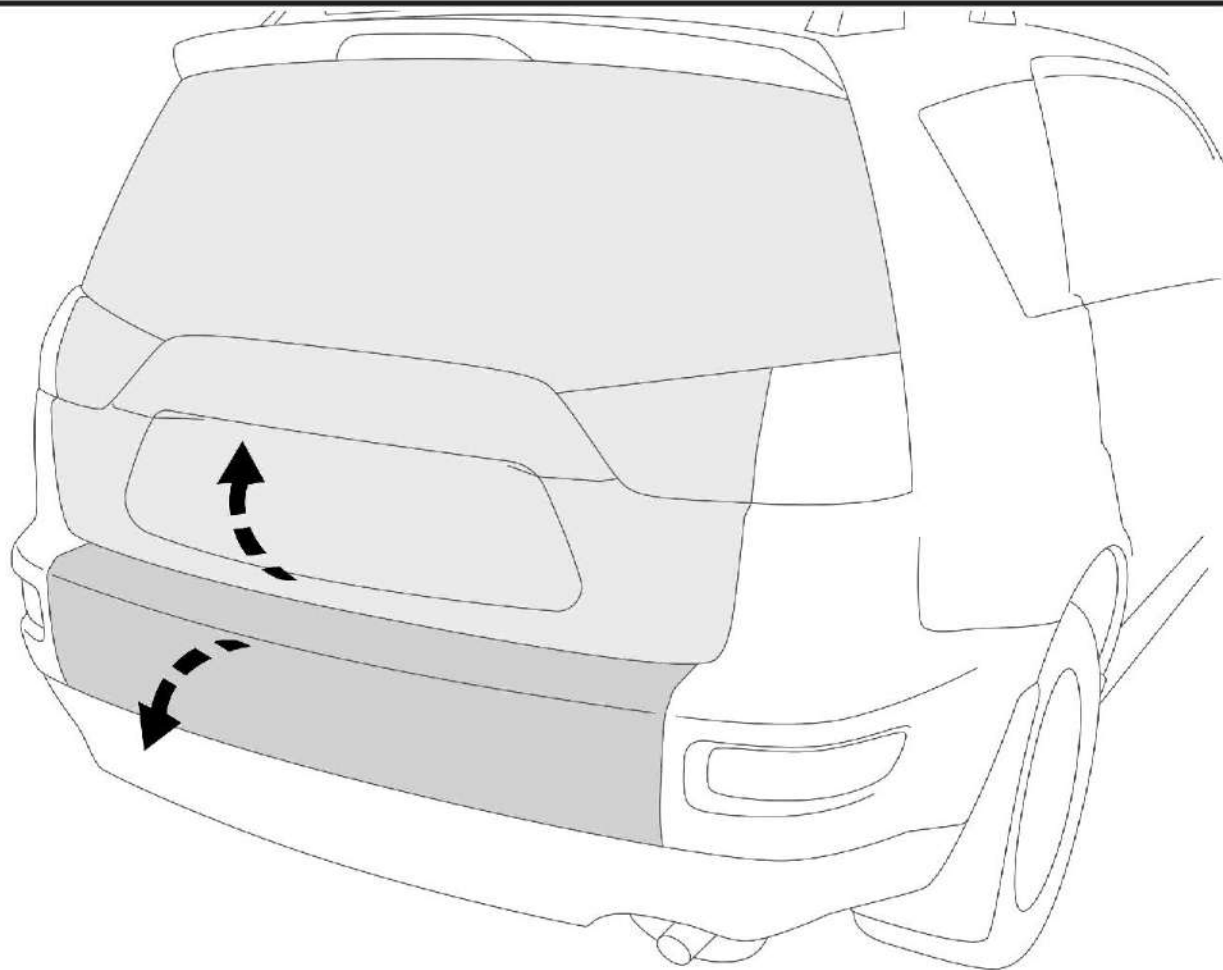

**1**

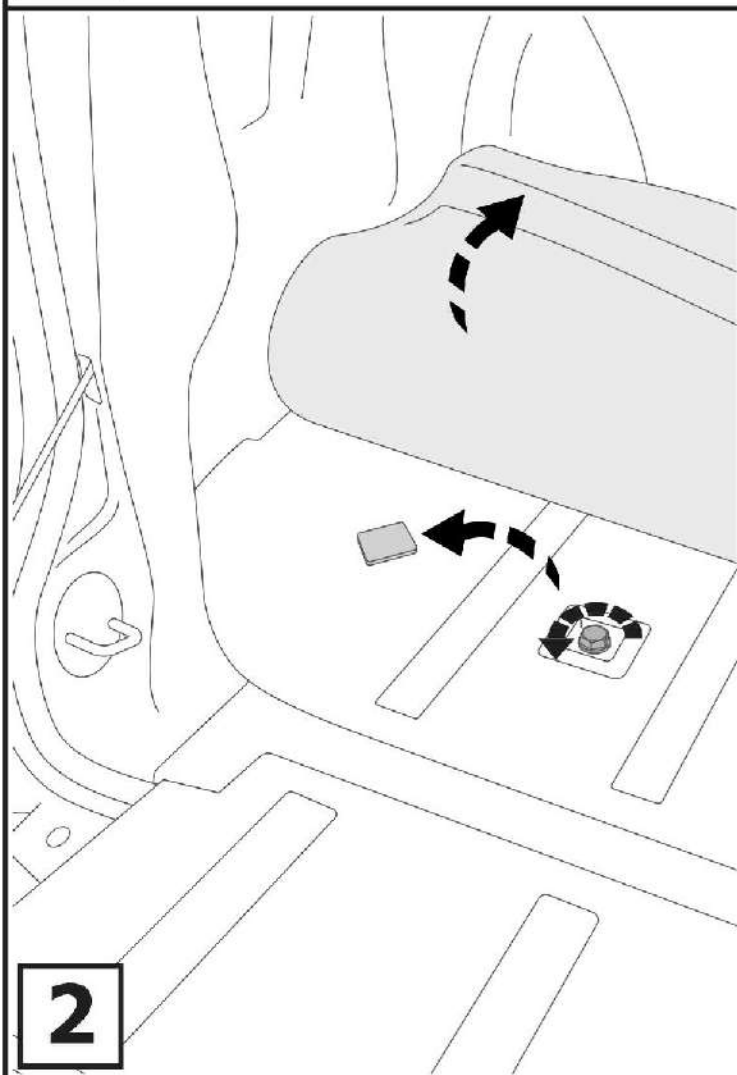

**2**

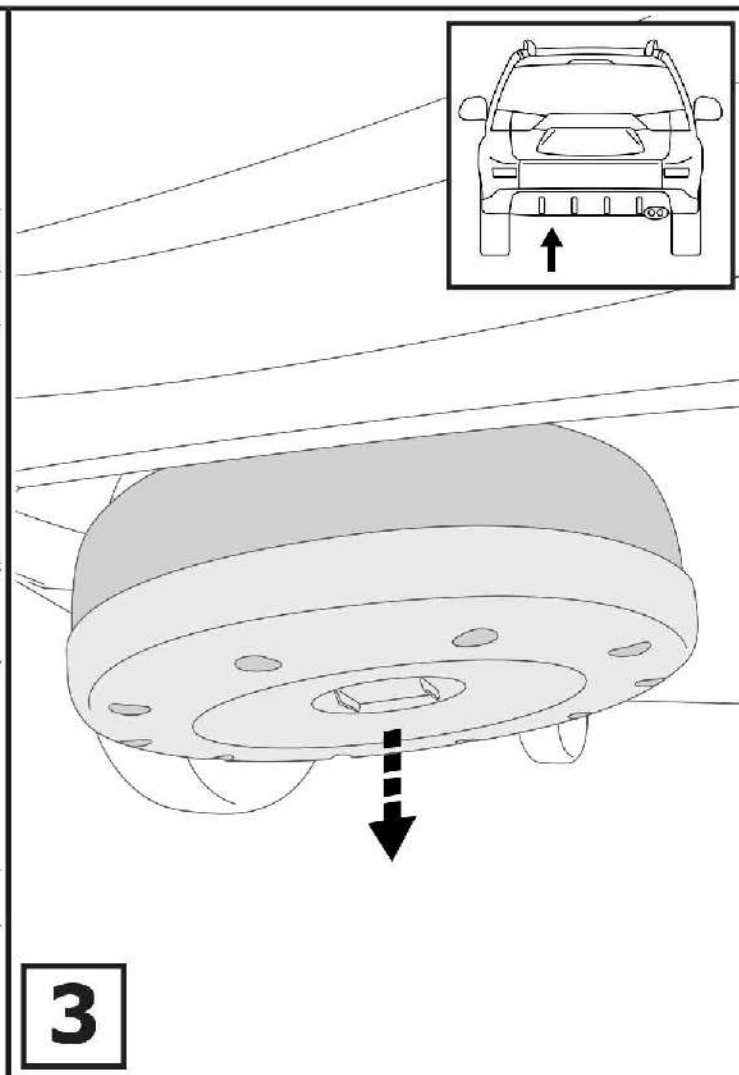

**3**

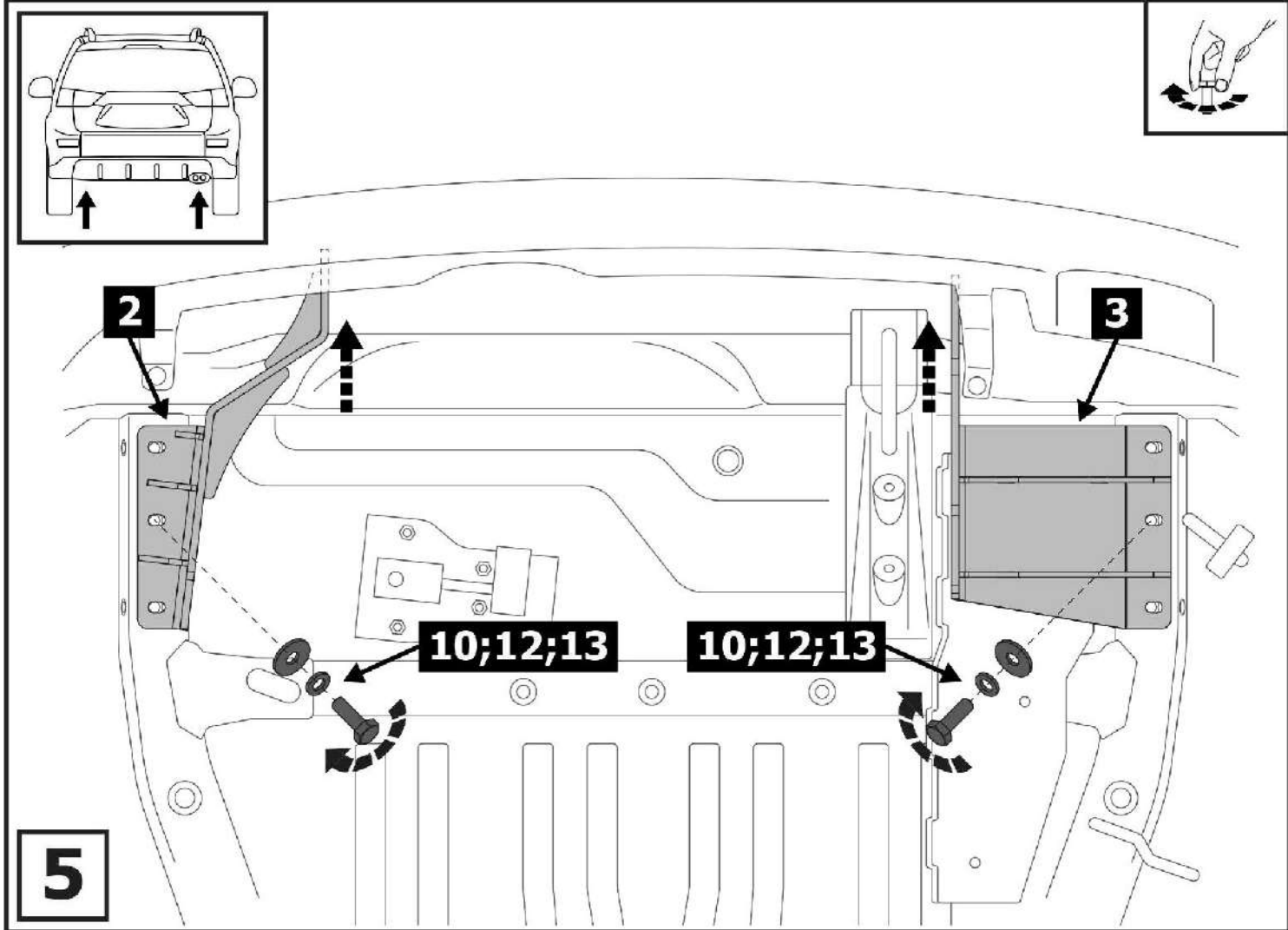
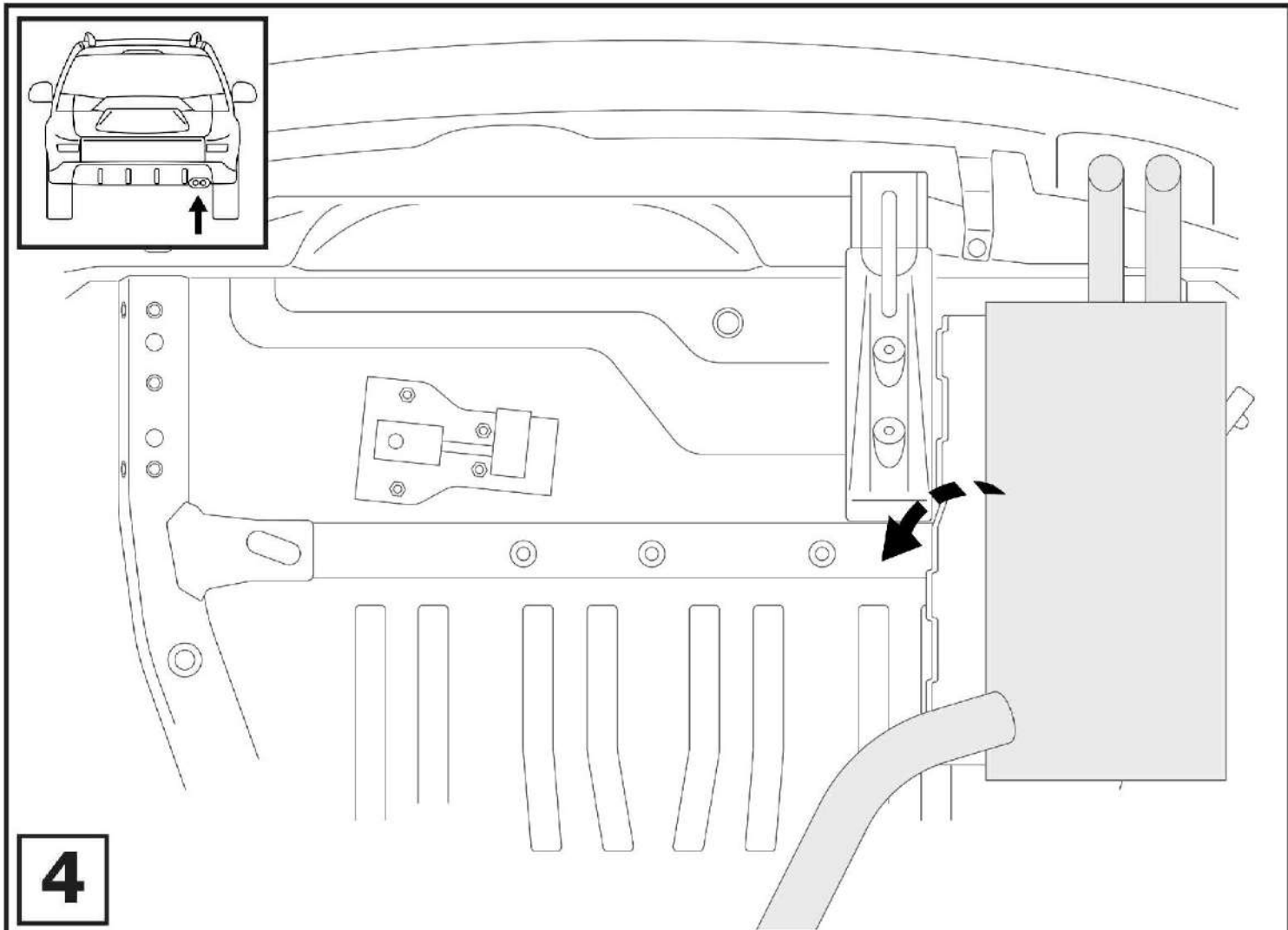

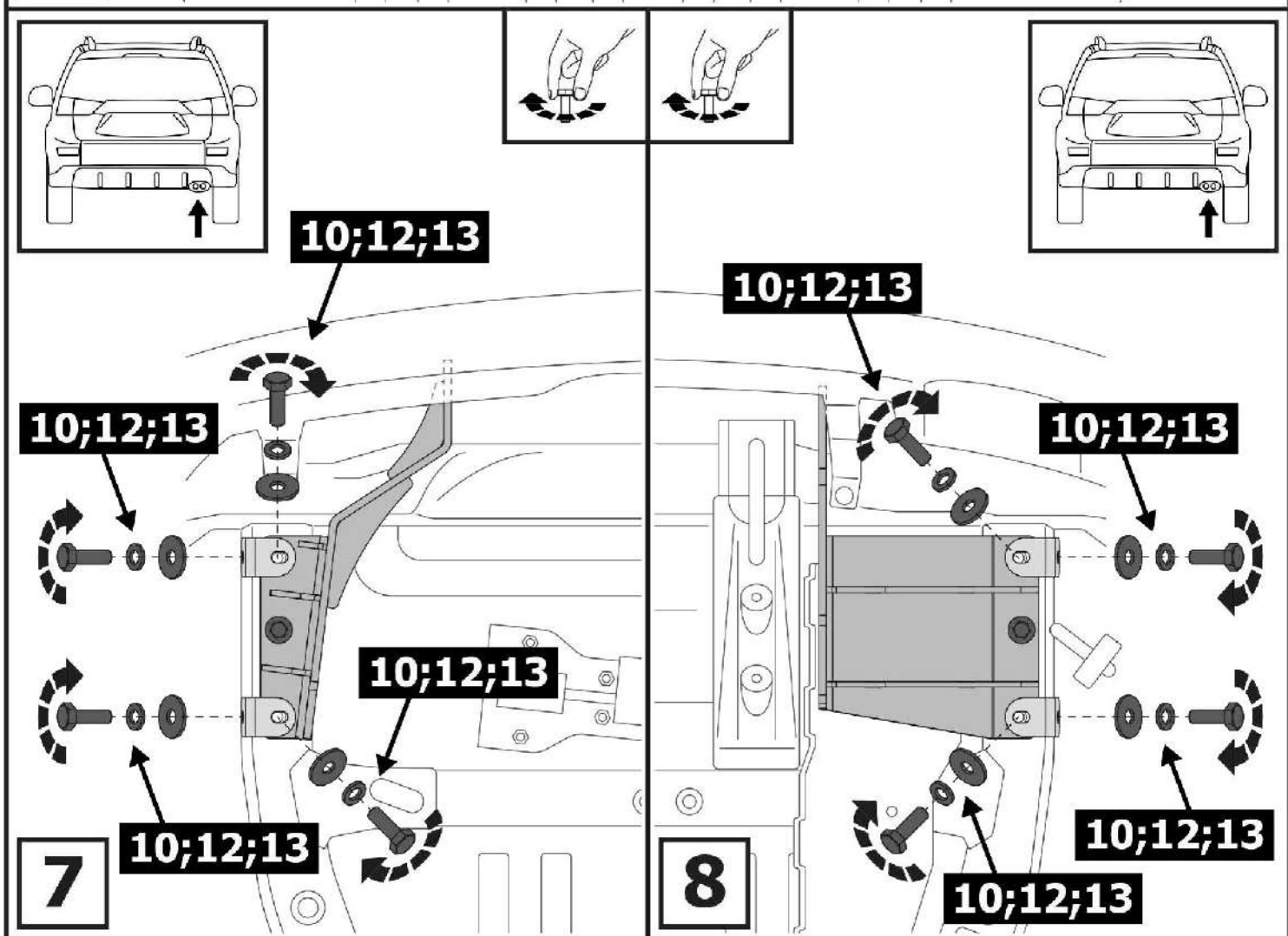
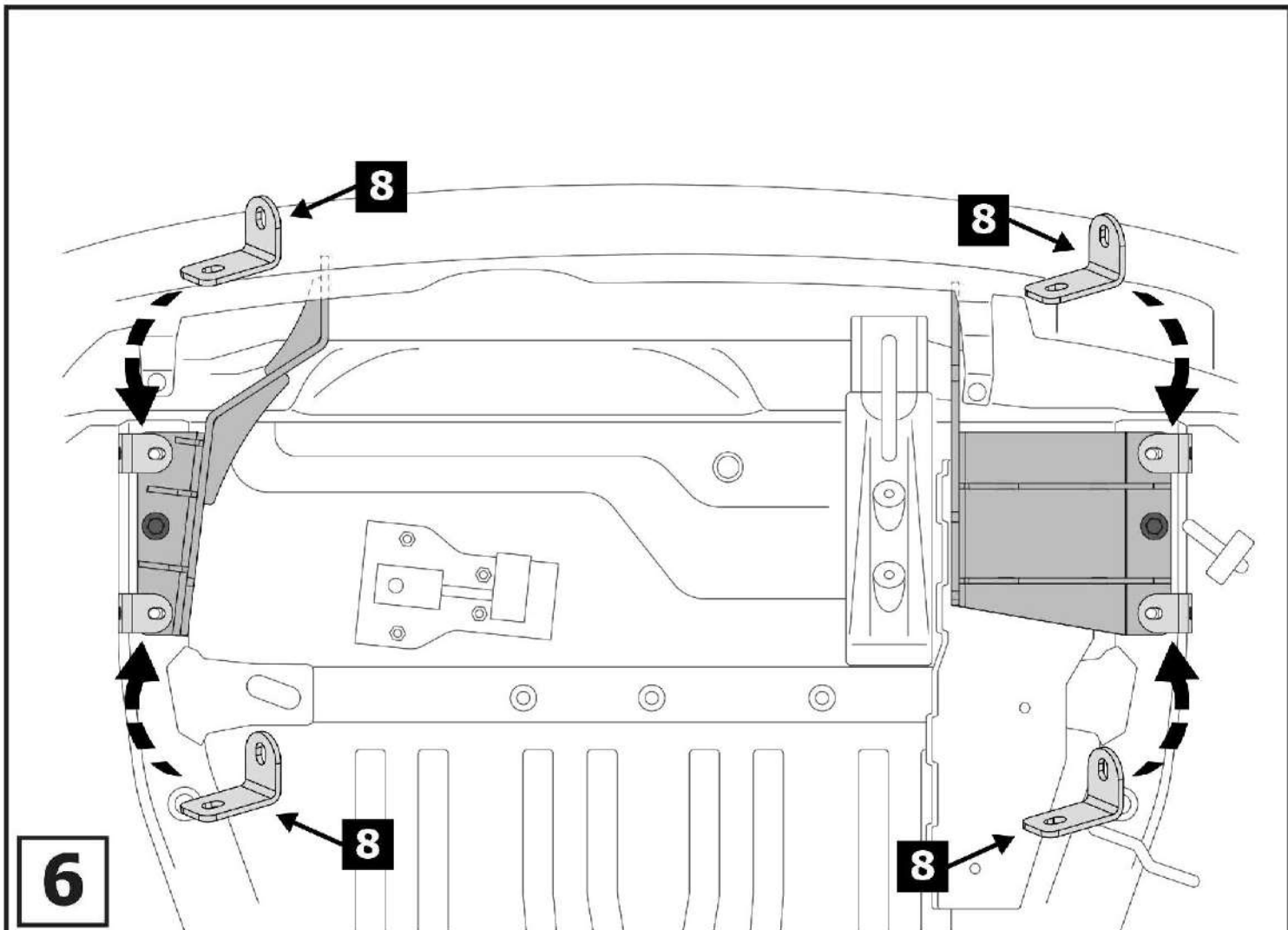

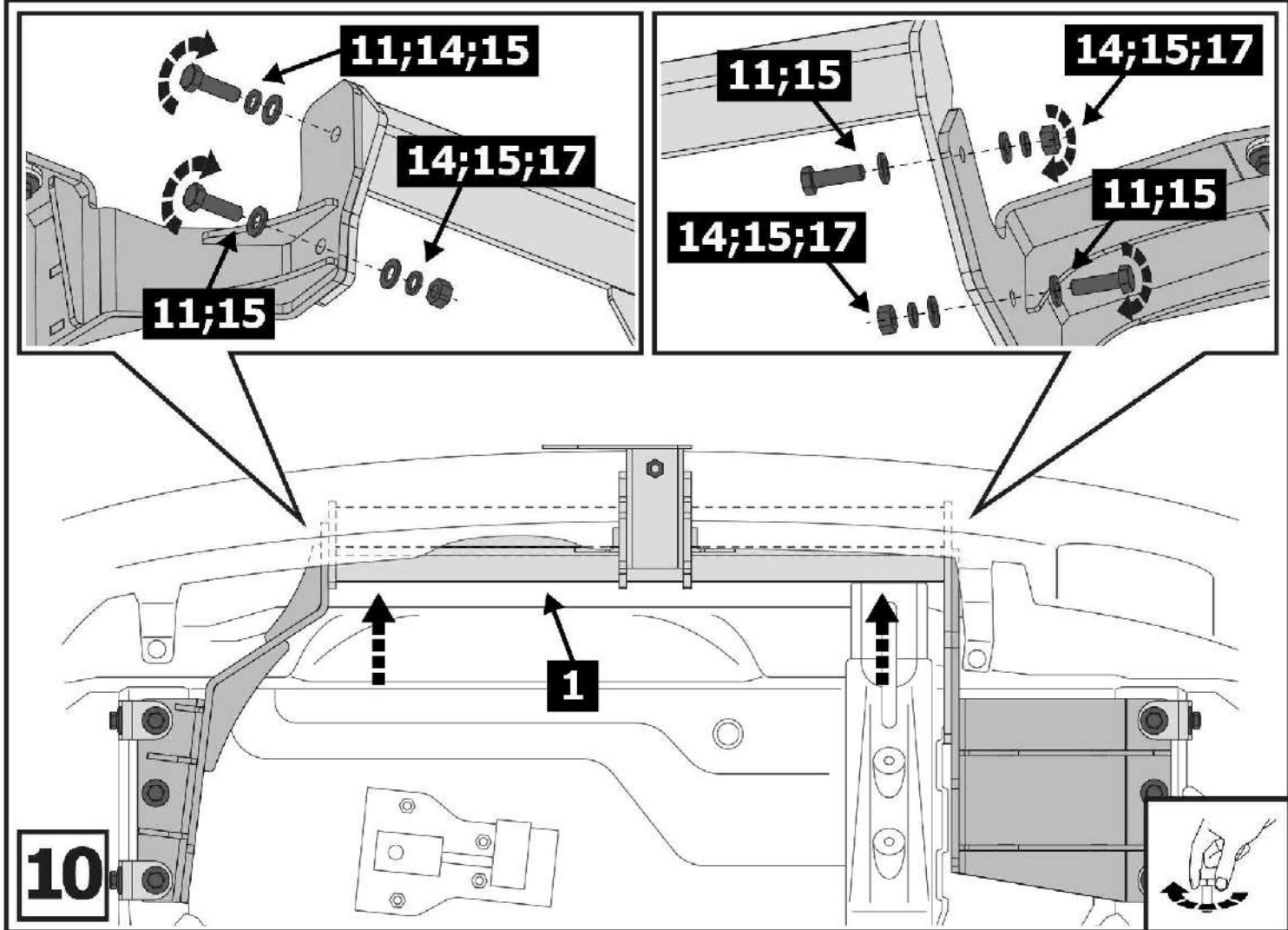
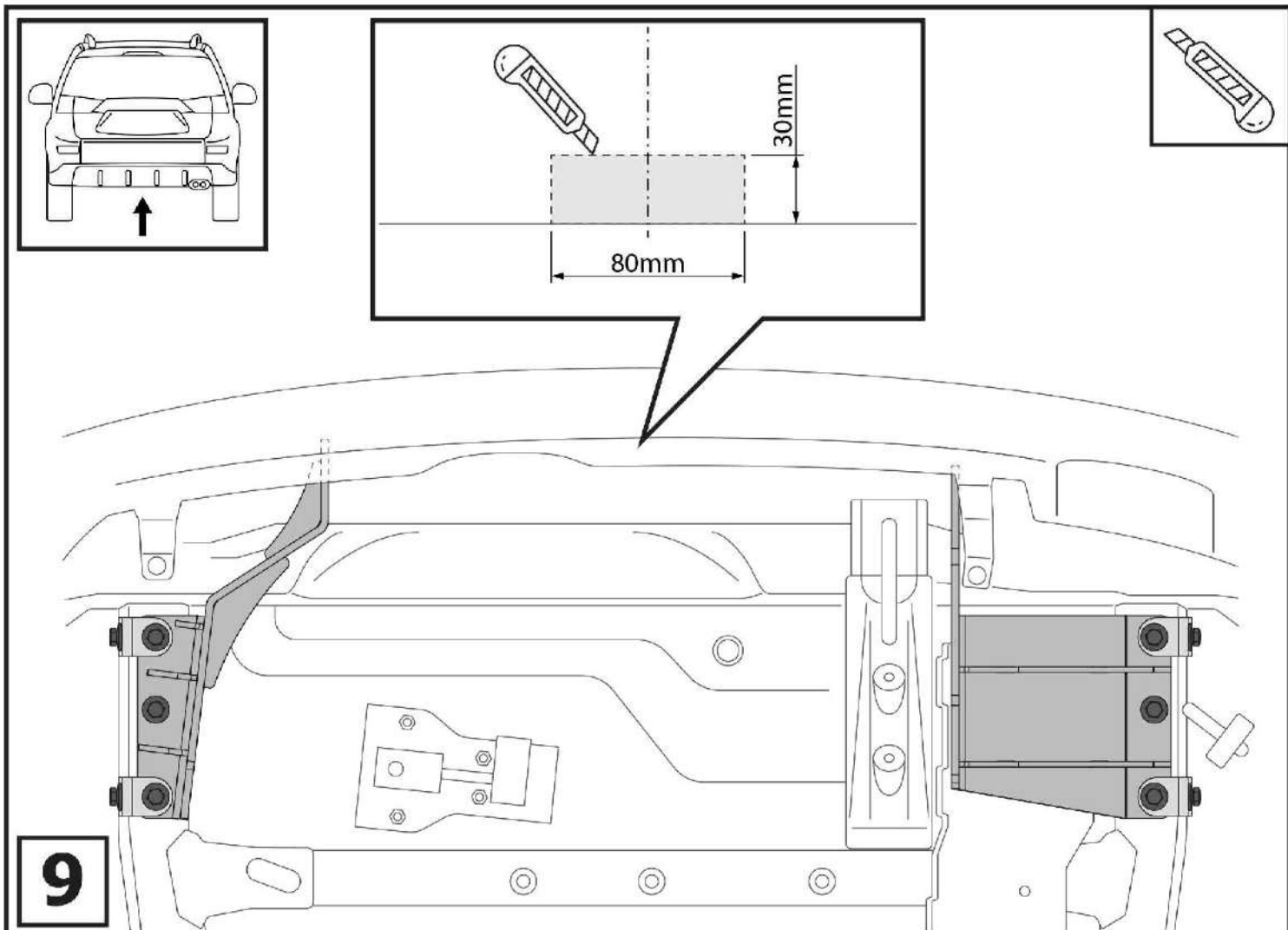

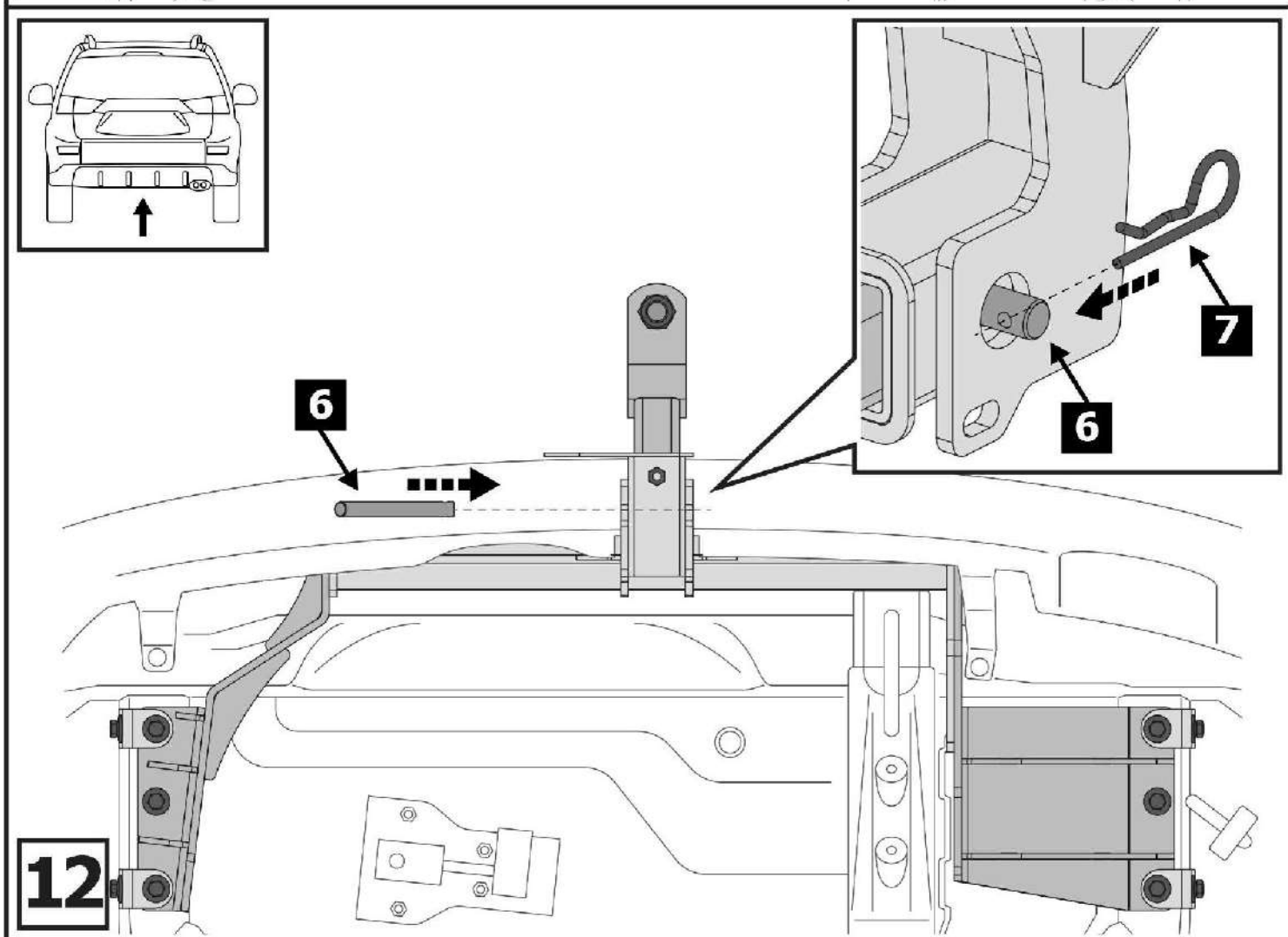
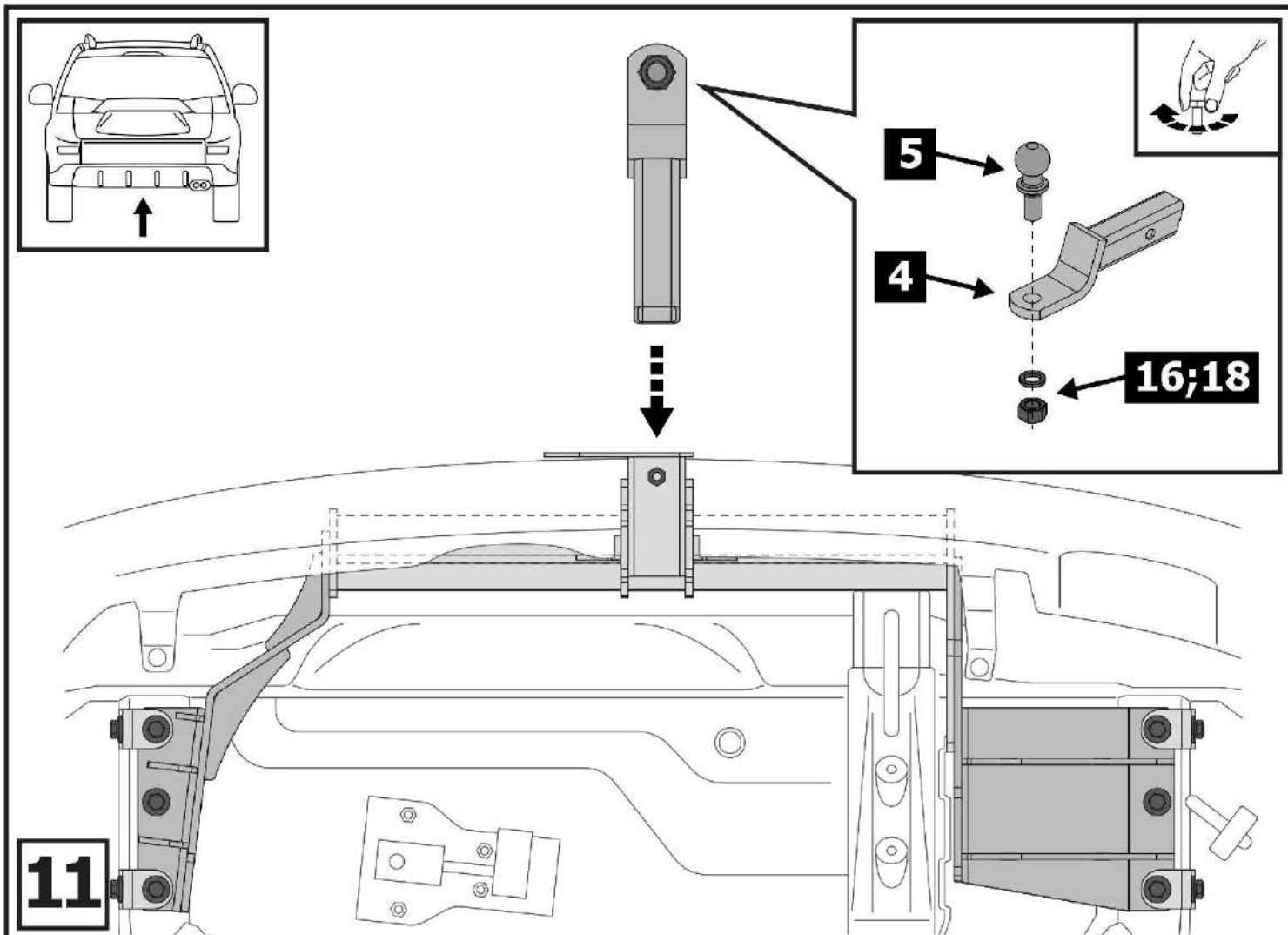



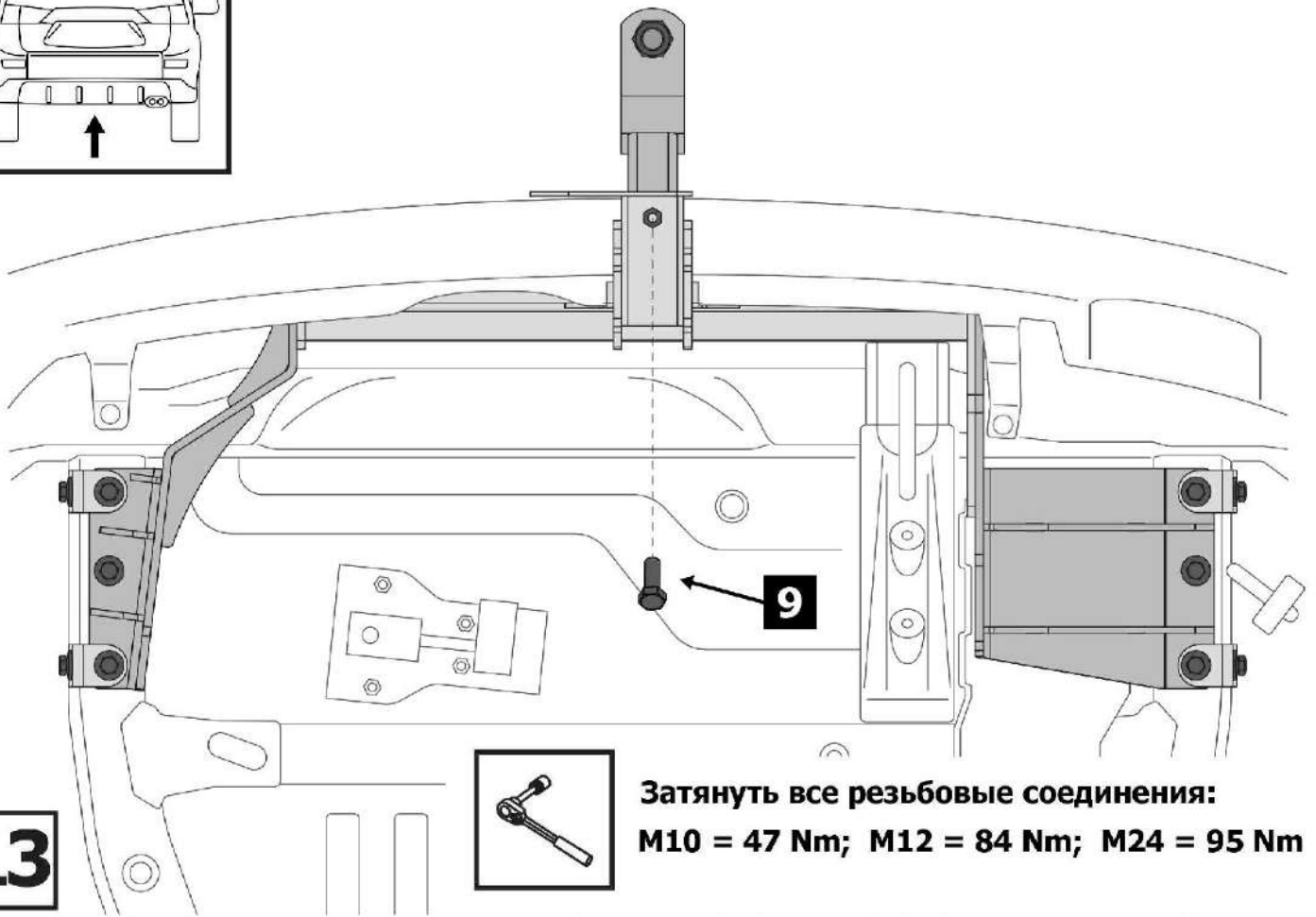
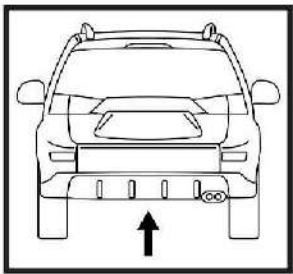

**Затянуть все резьбовые соединения:**  
**M10 = 47 Nm; M12 = 84 Nm; M24 = 95 Nm**