

Инструкция по установке **KIA RIO**

(2017-2020 / 2020 без ПТФ-)

HYUNDAI SOLARIS

(2017-2020 / 2020-)



Арт.: F.2311.001

Тип шара - «А»

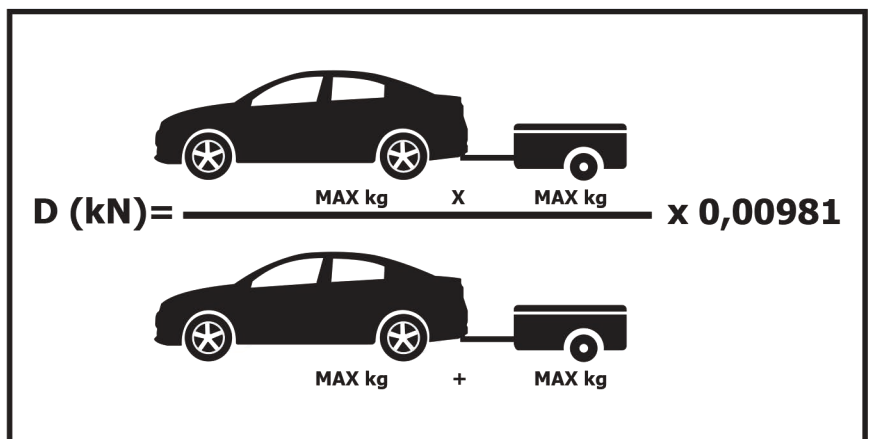
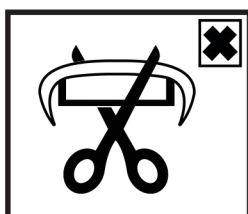
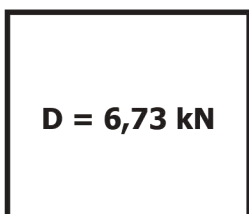
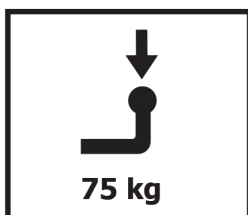
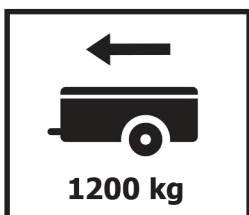

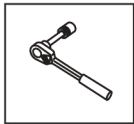

Вкрутить/выкрутить используя инструмент

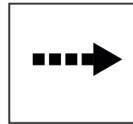

Движение

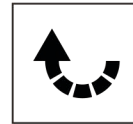

Поворот



Вкрутить/выкрутить не затягивая

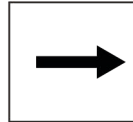





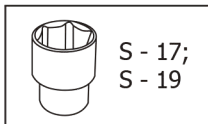
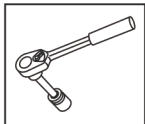



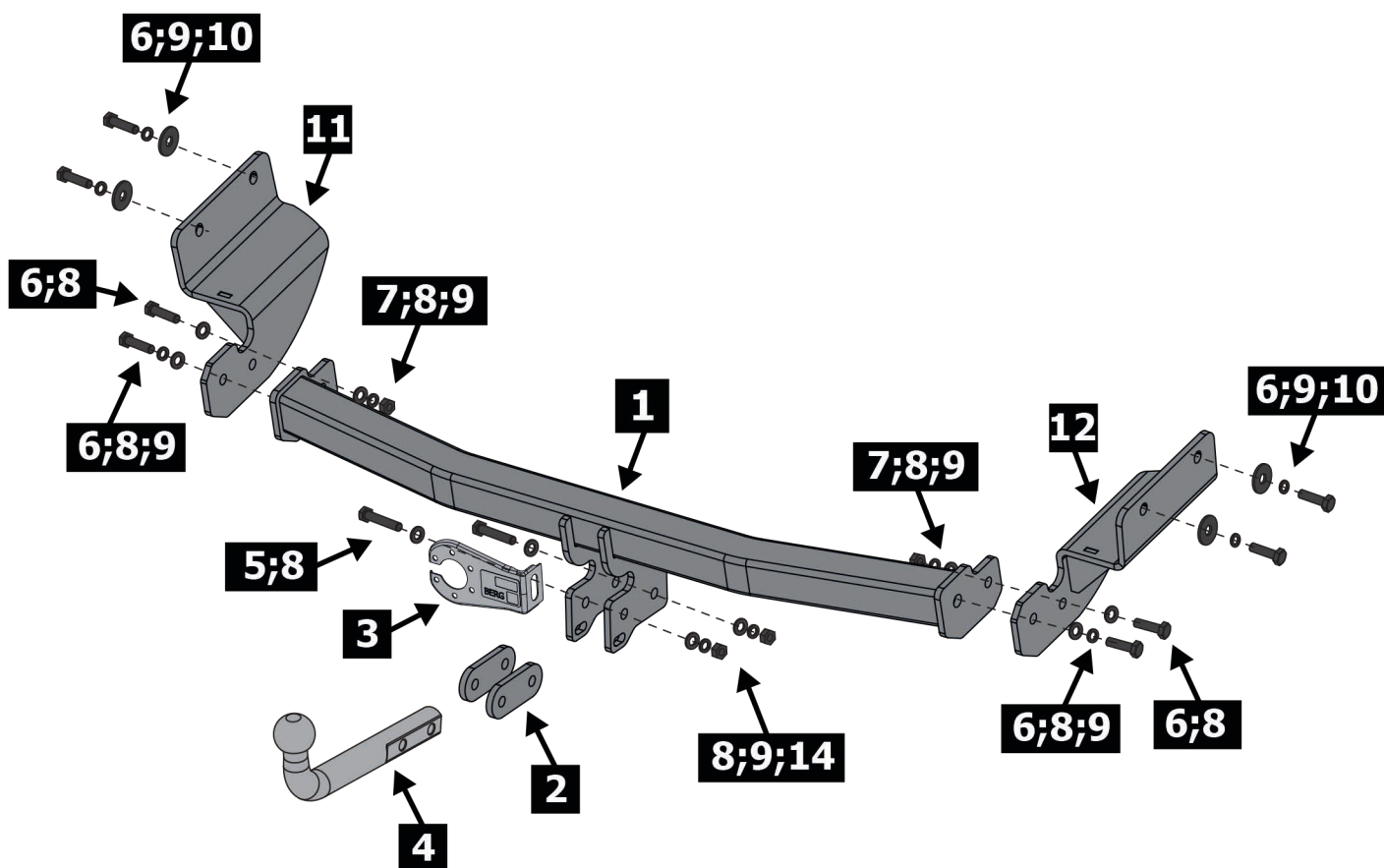

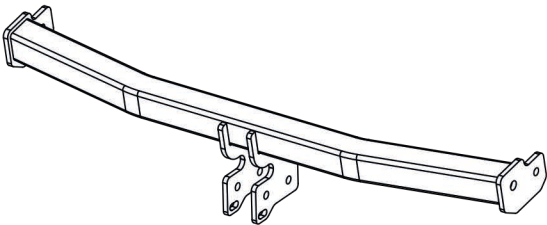
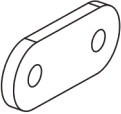
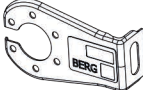
Расположение

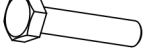
Используемый инструмент:



S - 17;
S - 19

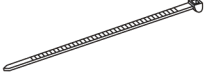

1	x1	Балка	
2	x2	Проставка	
3	x1	Подрозетник	
4	x1	Крюк	
5	x2	M12x90	
6	x8	M12x1.25x40	
7	x2	M12x1.25	
8	x10	∅ 12	
9	x10	∅ 12	
10	x4	∅ 12	
11	x1	Кронштейн	
12	x1	Кронштейн	
13	x3	Хомут-стяжка	
14	x2	M12	

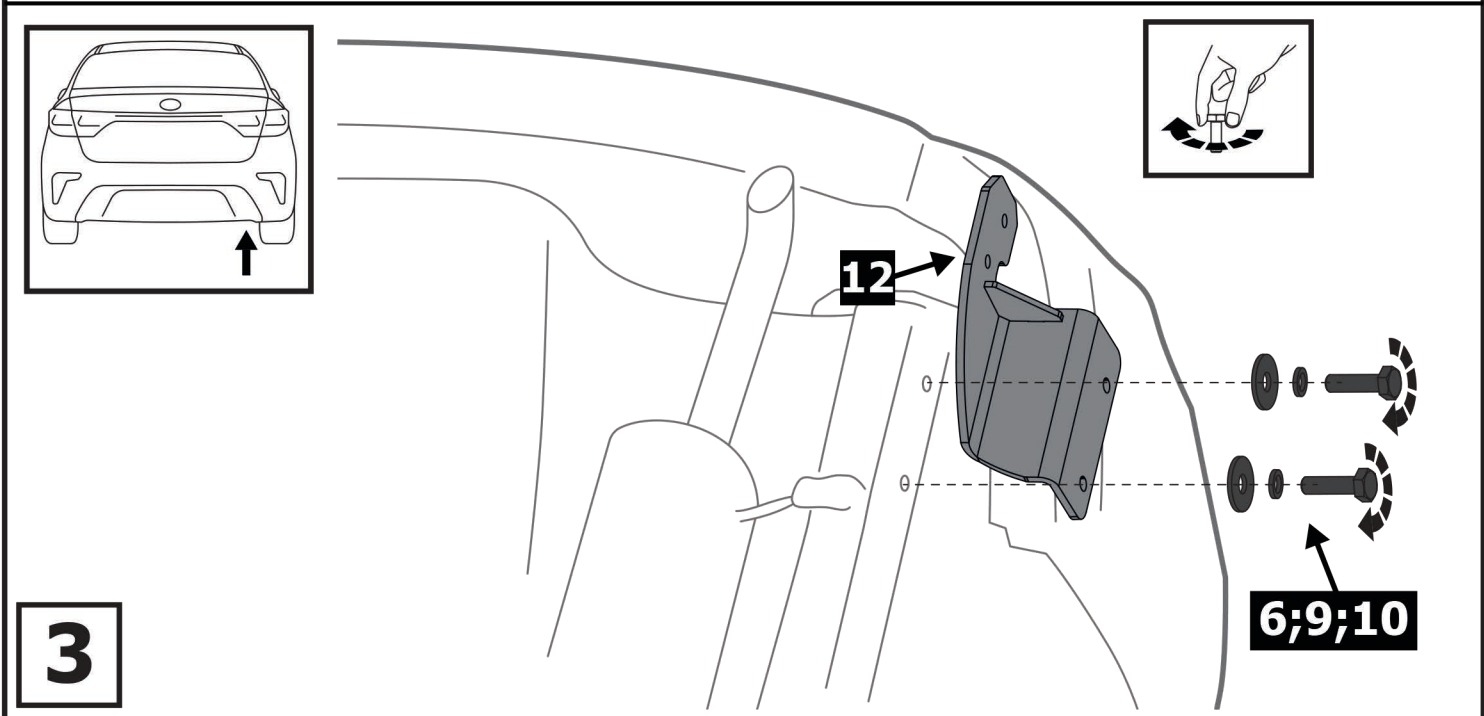
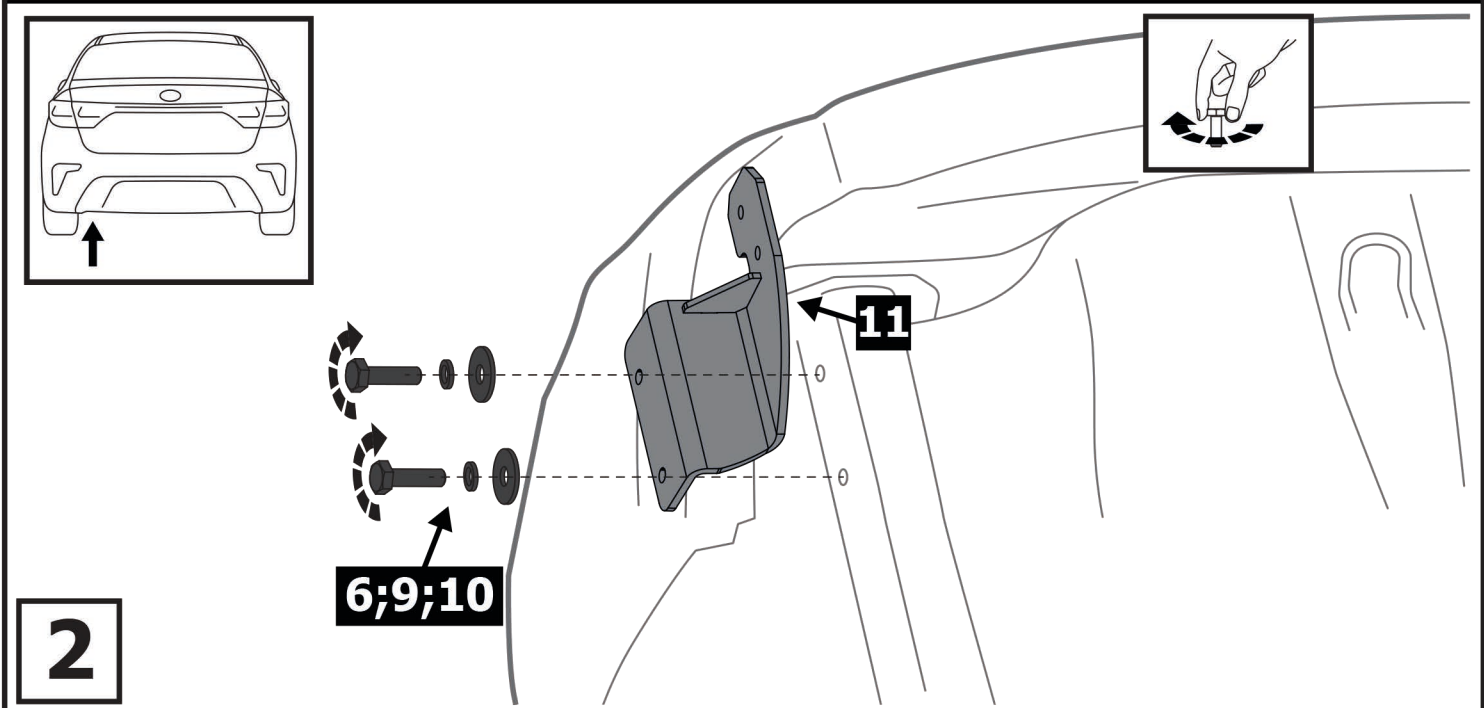
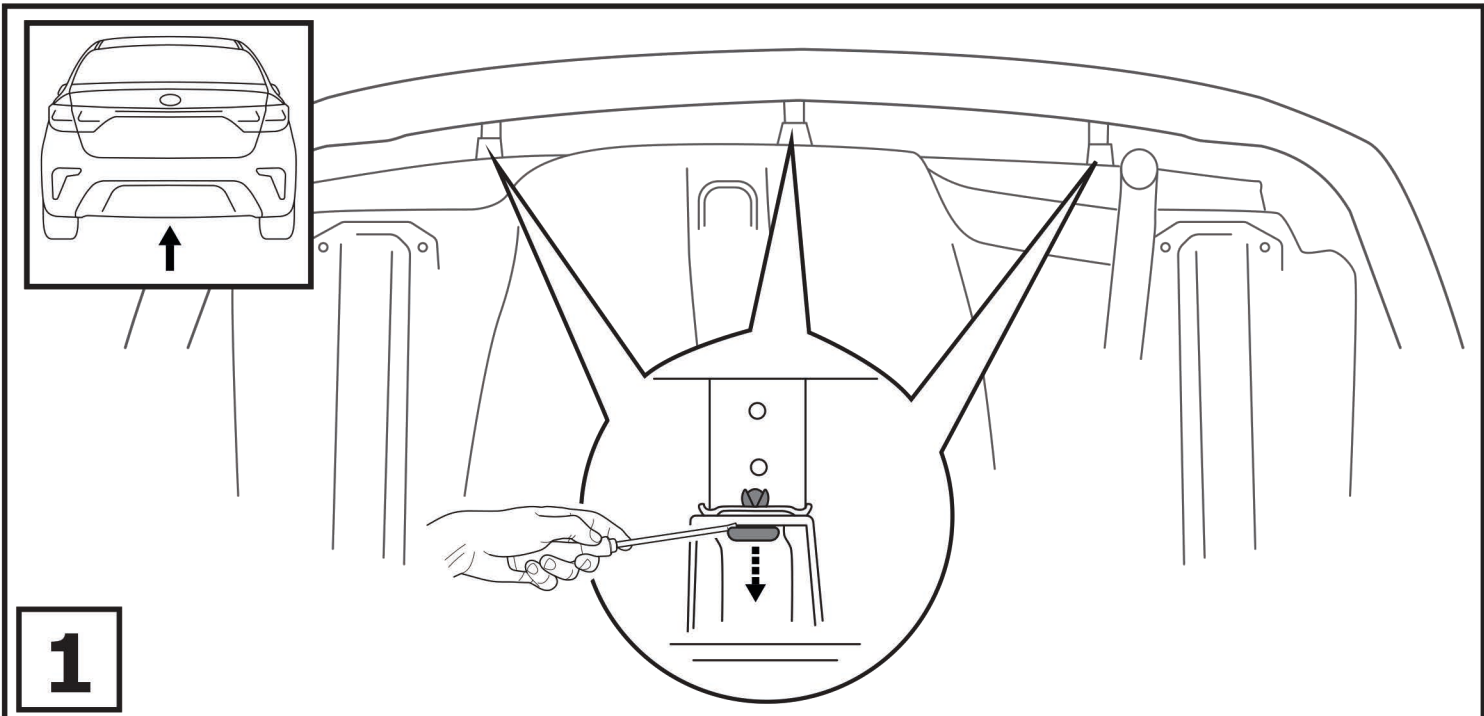

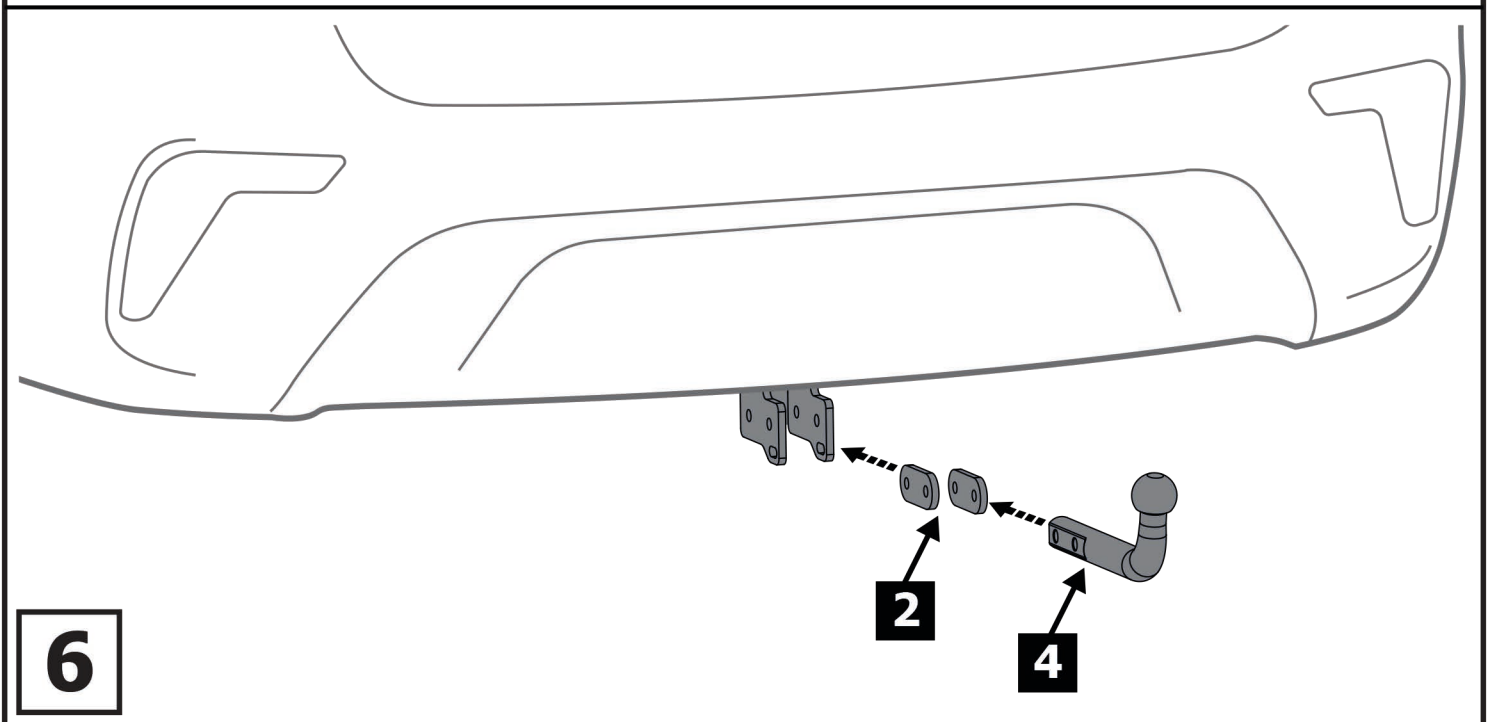
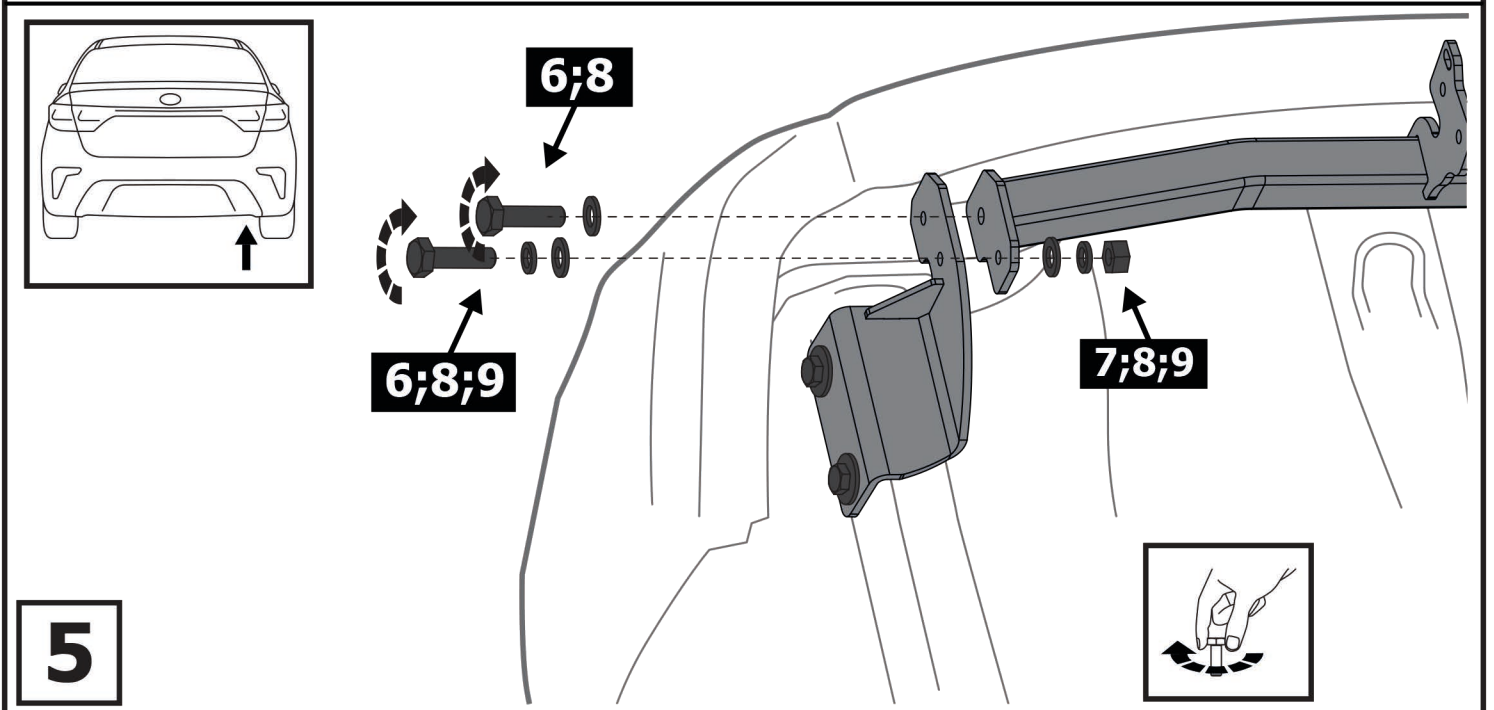
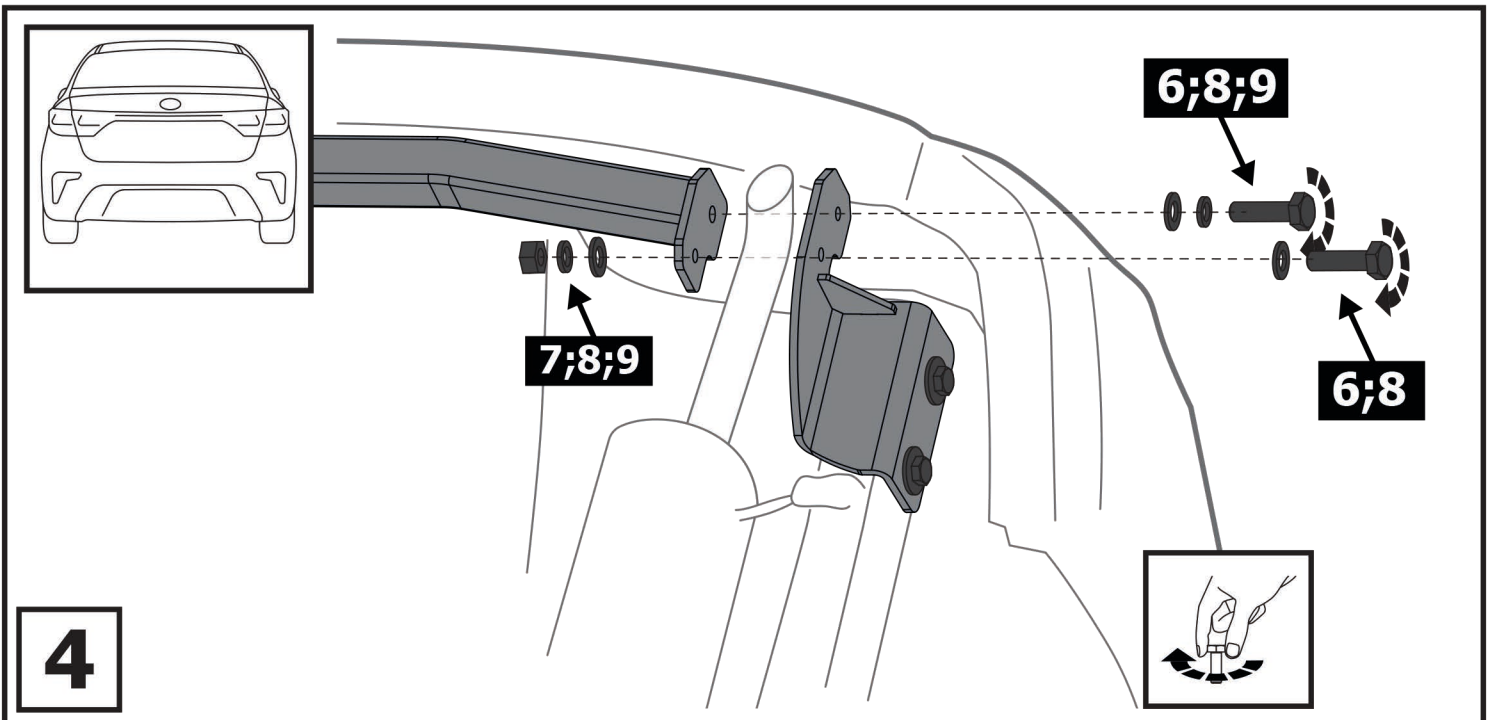

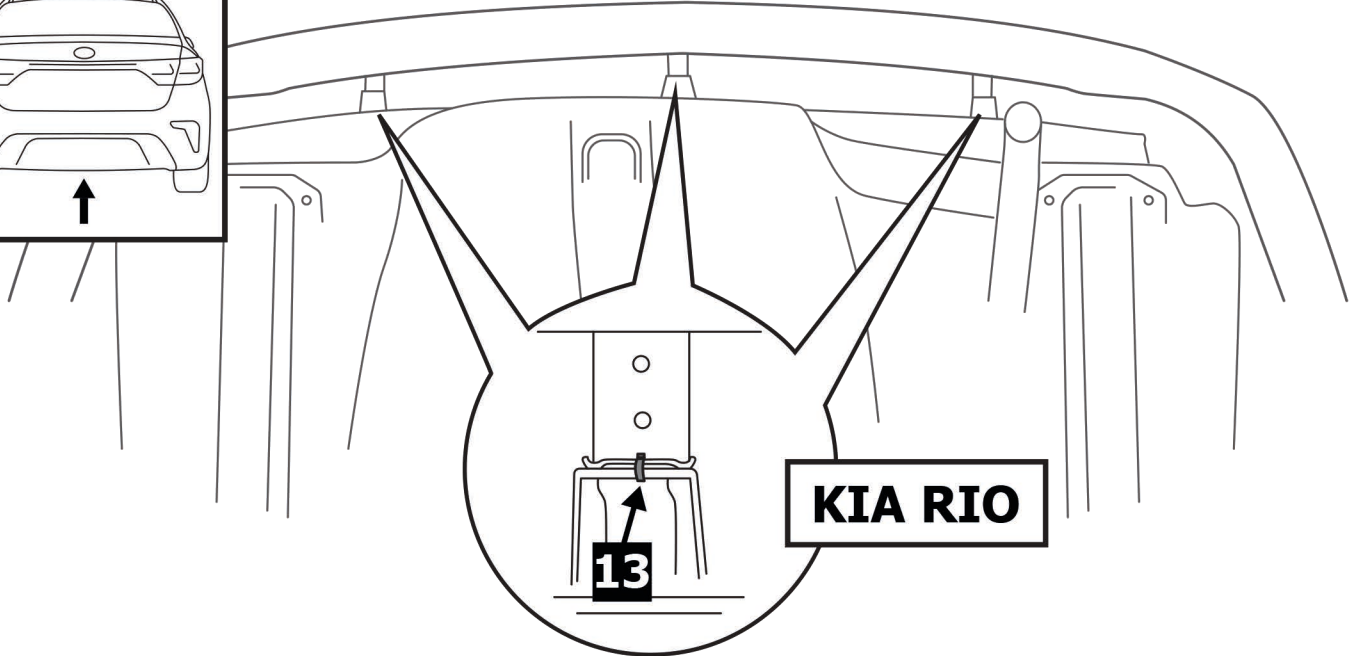
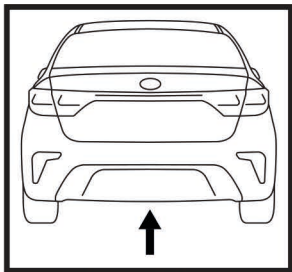

KIA RIO

13

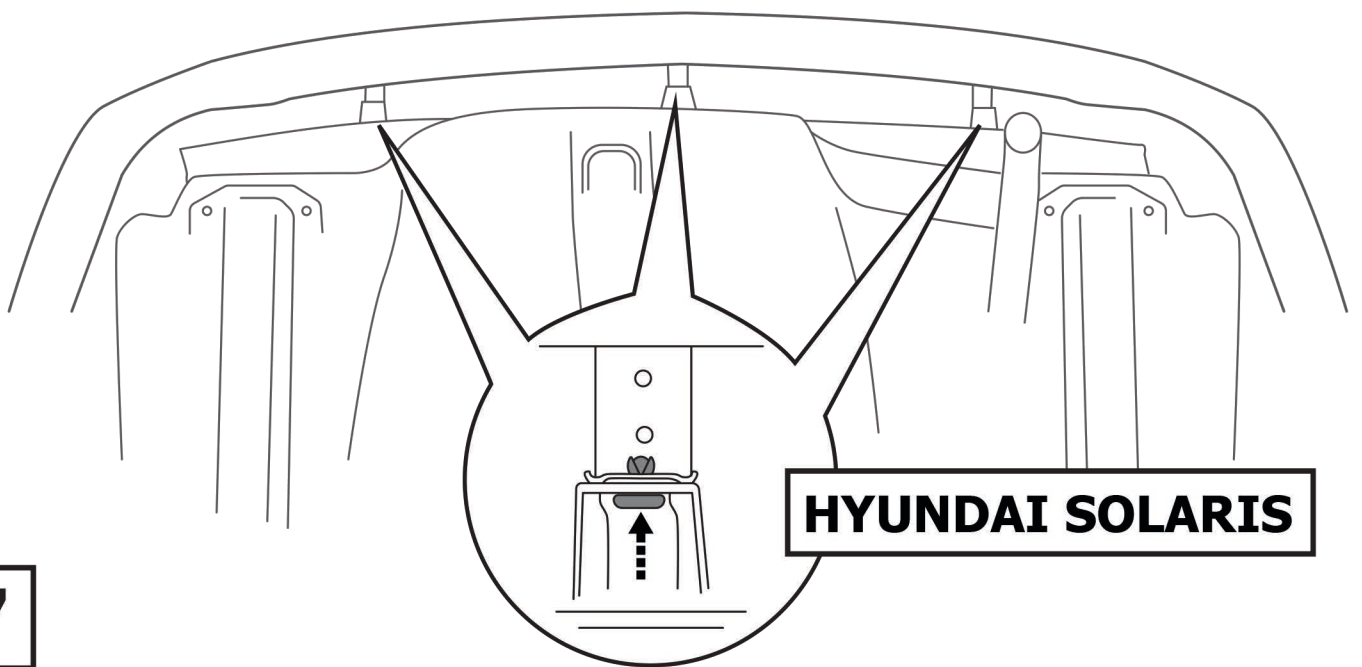

HYUNDAI SOLARIS

7

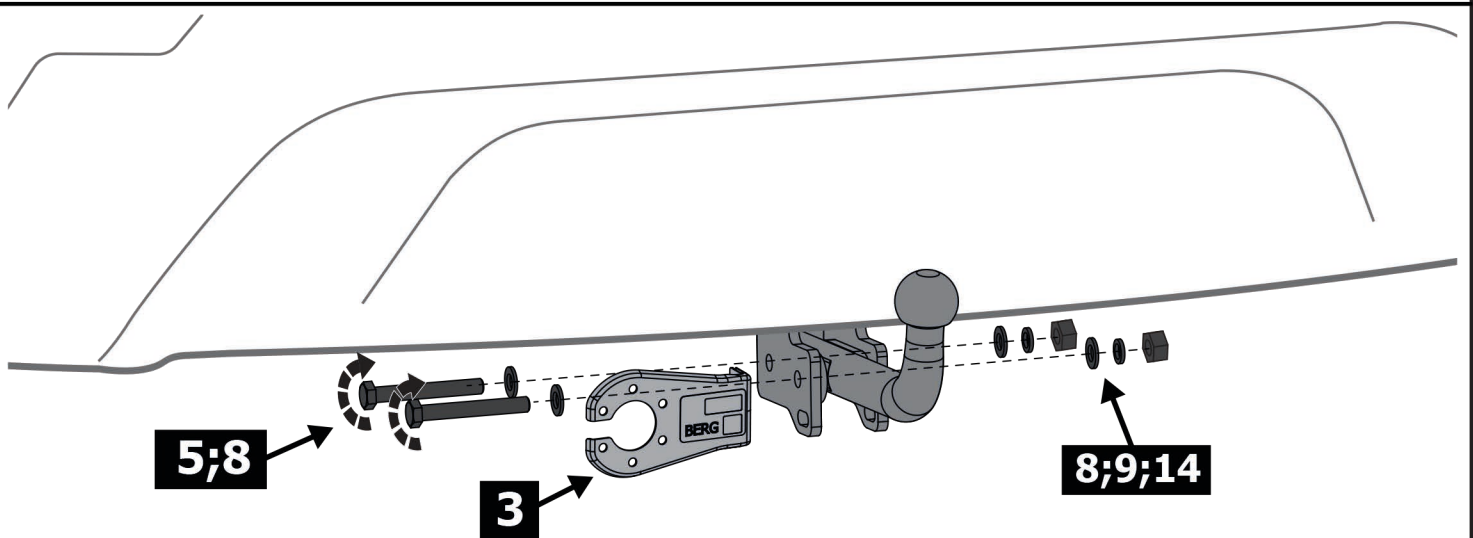

5;8

3

8;9;14

8

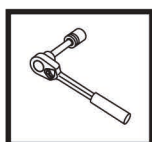

**Затянуть все резьбовые соединения
M12 = 81 Nm**